

THERMOELECTRICALLY COOLED PHOTODIODE

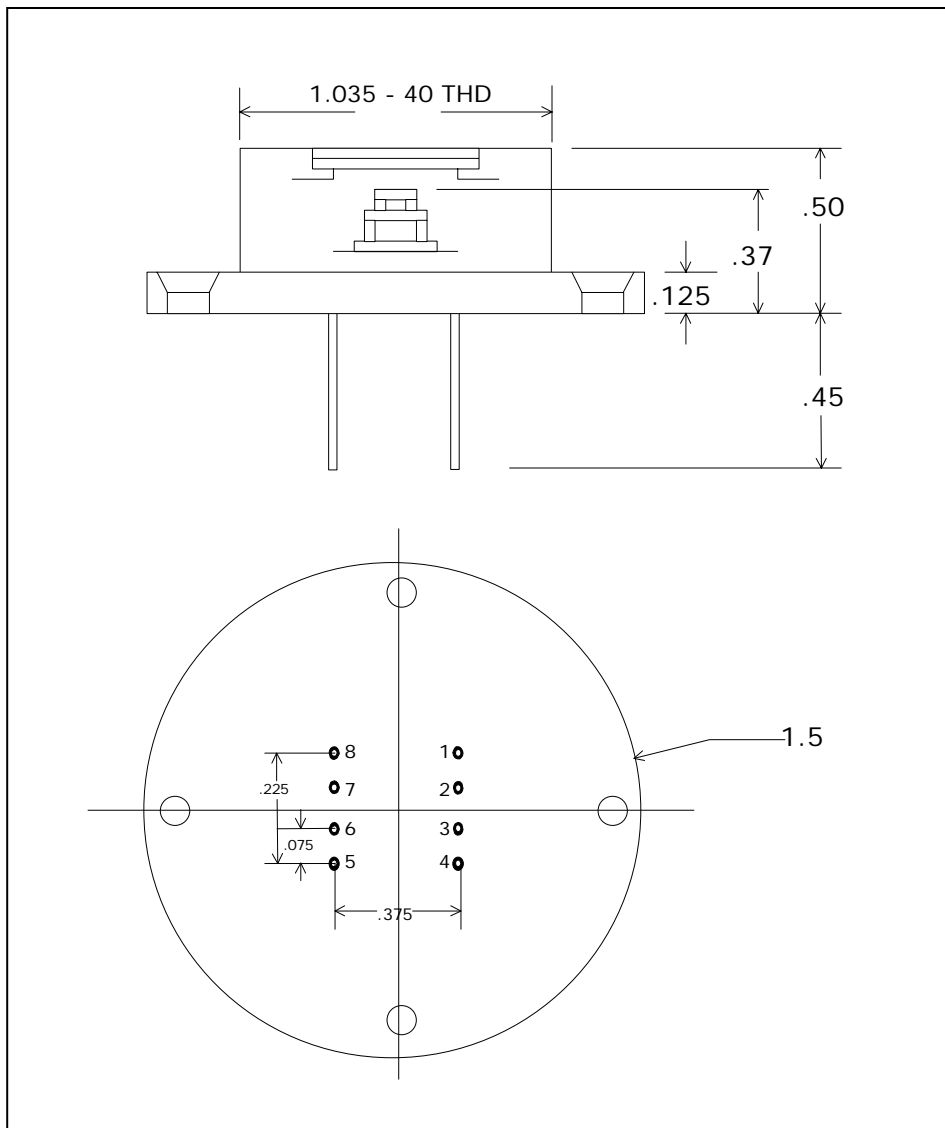

Part No:

S-100-TE2

PIN FUNCTION

- 1 = Cooler (-)
- 2 = Thermistor
- 3 = Thermistor
- 4 = Cooler (+)
- 5 = Detector Cathode
- 6 = Detector Anode
- 7 = No Connect
- 7 = No Connect

Note:

Dimensions in Inches

SPECIFICATIONS

Detector Type	10 mm x 10 mm Silicon Photodiode	
Temperature (°C)	22	-20
R _{shunt}	10 M ohms min	500 M ohms min
C _{shunt}	1000pf typ	1000pf typ
NEP @ 850 nm	< 1.0 x 10 ⁻¹³	< 1.0 x 10 ⁻¹⁴
Responsivity (A/W)	0.5 min @ 850 nm	0.5 min @ 850 nm
Cooler Current (A), typ	0.0	0.7
Thermistor Resistance (kΩ)	1.5	20.0