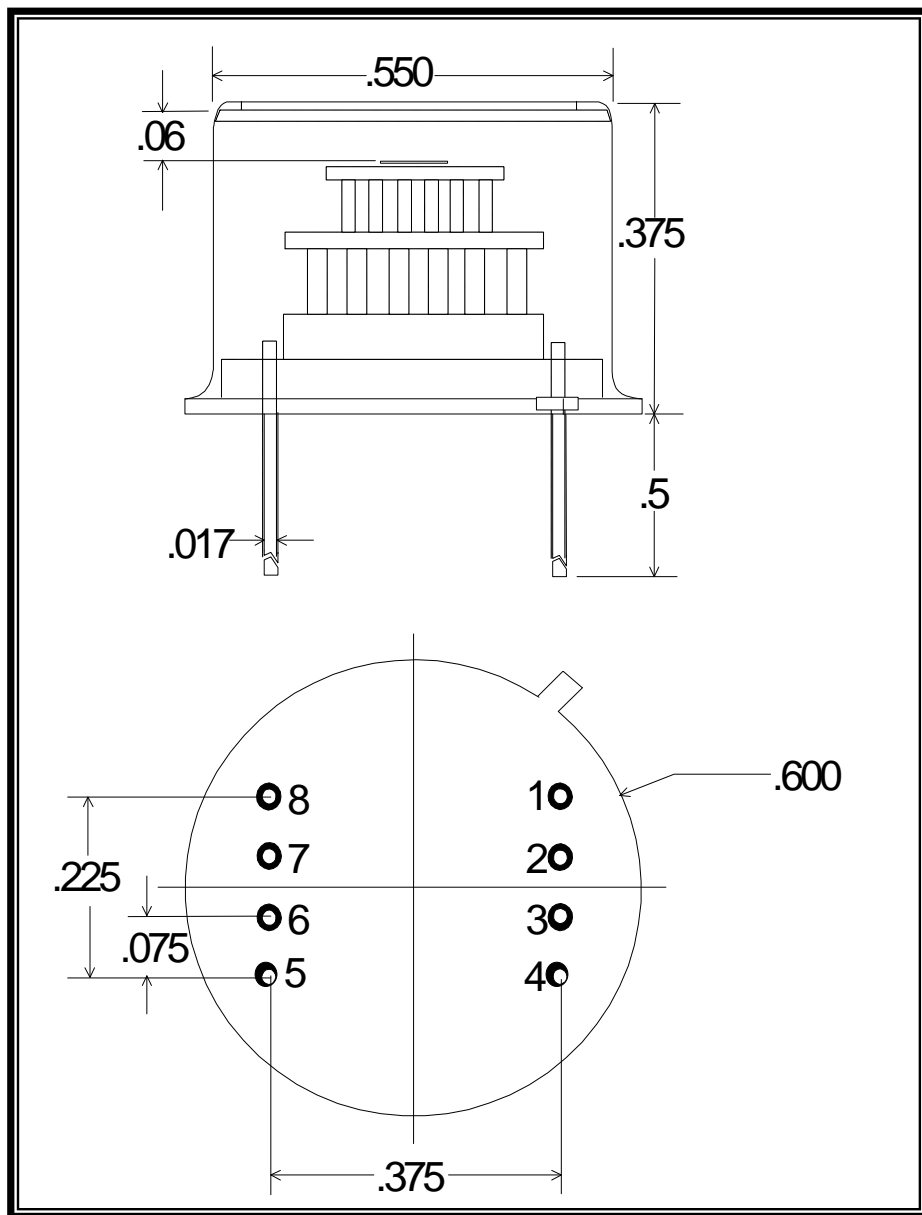

TE COOLED PBSE - SERIES PHOTOCONDUCTOR

Part No:
PBSE - 050 - TE2
PIN OUT

- 1 = COOLER (-)
- 2 = THERMISTOR
- 3 = THERMISTOR
- 4 = COOLER (+)
- 5 = DETECTOR
- 6 = DETECTOR
- 7 = NO CONNECT
- 8 = NO CONNECT

Note: Dimensions in inches

Operating Note

The TE cooled photodetector series consists of a high performance photodetector mounted on a thermoelectric cooler, all housed in a TO-8 package. A thermistor is mounted to the TEC's cold plate to provide a precise, reliable temperature monitor. Before operation VERIFY ELECTRICAL WIRING, else catastrophic damage may be sustained by the unit. Electrical power consumption can exceed 2.5 Watts (2V / 1.25A); therefore, this package must be suitably heat sunk. Thermal grease with secure clamping is recommended for power dissipation. Temperature levels below -45°C are possible with an optimized mechanical assembly.

SPECIFICATIONS

Detector Type	5mm x 5mm PbSe Photoconductor	
Operating Temperature (°C)	22	-30
Shunt Resistance (MΩ)	0.1 - 1.0	.5 - 3.0
D* (pk, 1 kHz, 1 Hz)	> 2 x 10 ⁹	1.0 x 10 ¹⁰
Responsivity @ pk (V/W)	1000	1 x 10 ⁴
Thermistor Resistance (kΩ)	1.6 typ	40 typ
Cooler Current (A)	0.00	0.60 typ
Maximum Cooler Current (A)	1.25	